

310103

3009. **GAZ**

Lateral Neumatico Side Mount Pneumatic

Descripción Description



Toma de fuerza de dos piñones en toma constante, para montar bombas ISO 4 taladros. Accionamiento neumático. Montaje sobre el lado derecho de la caja de cambios. Indicador de funcionamiento opcional.

Power Take-off two gears, constant mesh, to connect ISO 4 bolts pumps. Pneumatic shifting. Mounting on right side of the Gearbox. Optional: Passing contact switch.

Datos Principales Main Data

Par nominal Torque (Nm)	Continuo Continuous	300
	Intermitente Intermittent	420
Potencia (Cv) a 1000 r.p.m. Power (HP) 1000 r.p.m.	42 C.V. // 32 Kw	
Lado de montaje Mounting position	Derecho Right	
Sentido de giro de la bomba Pump rotation	Derecho Right Hand	
Peso Weight (Kg)	10	
Relación motor – Toma de Fuerza Engine to PTO ratio	1:0.847	

Codigos y Combinaciones Codes and Combinations

Tipos de salida Output types	Plato Flange	Bomba Pump (DIN 5462)
Accionamiento neumático	310102	310103

310103

3009. **GAZ**

Lateral Neumatico
Side Mount Pneumatic

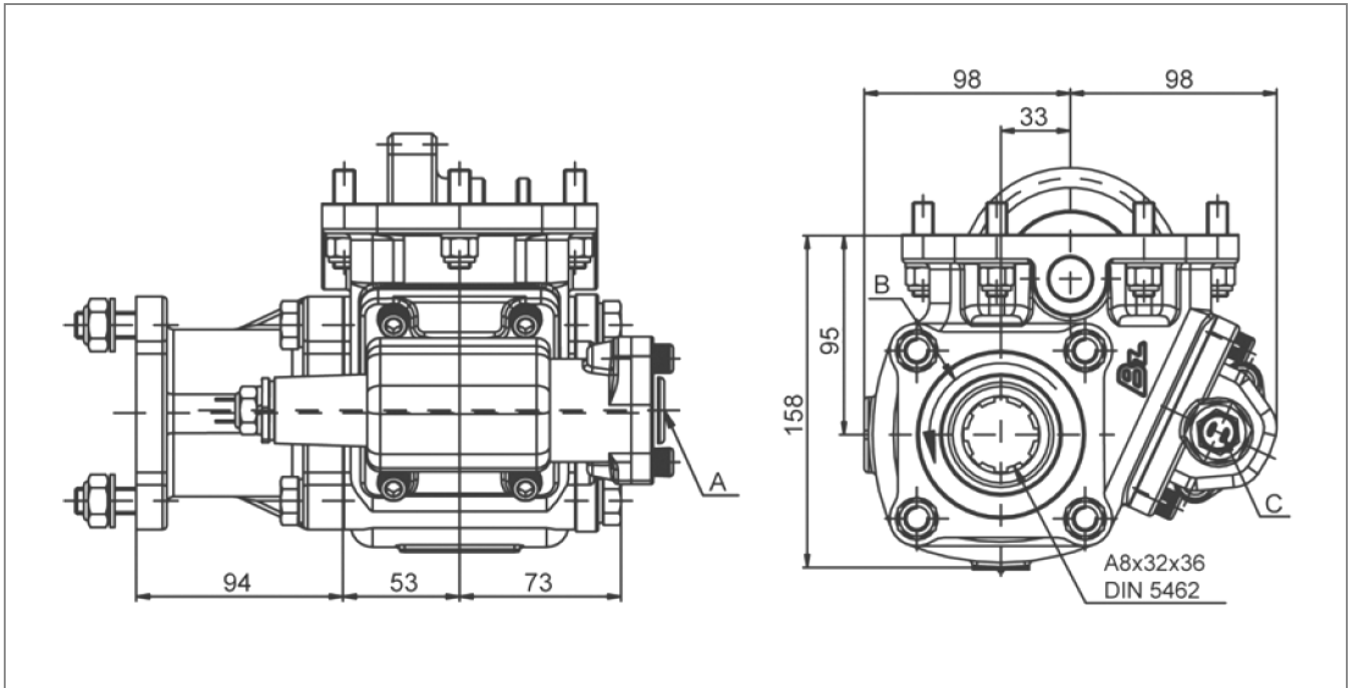

Datos Principales Main Data

A	Toma de aire, rosca 1/4" GAS	A	Air connection, thread 1/4" BSP
B	Sentido de giro	B	Rotation
C	Indicador de funcionamiento (100070003)	C	Passing contact switch P/N 100070003

Tipos de salida Output Types

